



**HYDRANT PART
DRAWINGS
HPD-03**

2025

February 05, 2025

For frost-free hydrants,
see HYDRASAN I Models
71000 and 71050.

MILD CLIMATE HYDRASAN® I

JOSAM MODELS 71020 and 71070 COMBINATION MILD CLIMATE HYDRANTS WITH VACUUM BREAKER-BACKFLOW PREVENTER AND PRESSURE RELIEF VALVE

— INSTRUCTIONS —

INSTALLATION OPERATION MAINTENANCE

CAUTION: Do not destroy this form — Leave with owner.

You have one of the finest mild climate hydrants available, JOSAM HYDRASAN I. Adherence to these instructions will ensure satisfactory installation and proper performance. Take a moment to read them now.

INSTALLATION

A. Model 71020 Assembly

If your hydrant is the box type (Model 71020), it will be necessary to assemble the wall box to the hydrant before proceeding with the installation. Open box cover using Control Key (1). Insert hydrant, inlet end first, through opening in box bottom. Be sure outlet (hose connection) is at right as you face box with cover hinged at top. With hydrant head flange seated in recess surrounding hole in box, secure hydrant in place by tightening the two set screws, in tabs or box bottom, against hydrant head.

B. Model 71020 and 71070 Installation

HYDRASAN I is installed, with head horizontal, outlet to right, in the manner typical to all mild climate hydrants. The face (front) of hydrant or hydrant wall box (with cover hinged at top) must be set with flange against finished wall overlapping wall opening provided for the hydrant. The hydrant must be level (plumb) and extend into or through the wall with inlet in or inside of wall. Grout the hydrant (and box) securely in place with mortar. Follow normal plumbing practice to make inlet connection. NOTE: This sequence may vary depending on job conditions. Refer to Figures 1 and 2.

BE SURE TO LEAVE CONTROL KEY AND HEX. KEYS 3/32" and 5/32" WITH OWNER.

CAUTION

If solder (sweat) connections are used, heat must be controlled to avoid damage to non-metallic hydrant components. For best results, remove pressure assist seal assembly (parts 4, 5, and 15) prior to soldering joint. Allow to cool before re-inserting pressure assist seal.

Before hydrant is put into service, water supply system must be flushed thoroughly to remove dirt and chips that could cause hydrant malfunction. Remove pressure assist seal assembly prior to flushing.

OPERATION

Refer to Figure 3 for identification of parts and features mentioned in these instructions.

A. ON-OFF

HYDRASAN I is turned on and off by Control Key (1). Rotate the key counterclockwise (left turn) to turn hydrant on and clockwise (right turn) to turn it off. Built-in stops prevent over-opening and over-closing. Some drainage after hydrant is turned off will be noted at outlet (hose connection) and Deflector Cover Drain (26). This is typical of mild climate hydrants and is not cause for alarm. NOTE: In the unlikely event of continuous drainage, it is a signal that service is necessary. This is covered in the Maintenance Section.

B. PRESSURE RELIEF

If a hose is attached at the time hydrant is turned off, and there is no nozzle on the hose, or if the nozzle is open, the hose will drain; however, if the nozzle is closed, the hose will not drain, but the pressure in the hose and hydrant will be relieved, dissipating through the Vent and Drain Ports (24) and Vacuum Breaker Ports (33), at which time there will be a momentary spurt of water from these ports.

C. VACUUM BREAKER-BACKFLOW PREVENTER

If for any reason a backflow condition should develop in the attached hose, i.e., pressure imbalance due to sudden supply pressure drop below outlet pressure, the Vacuum Breaker Seal (29) will instantly respond opening Air Ports (33), to break any vacuum and sealing against Piston (31) to prevent backflow from the attached hose and protect the water supply system from entry of contaminants.

D. BOX TYPE — MODEL 71020

Control Key (1) locks and unlocks the box. Do not store the key in the box. The cover should be kept closed and locked at all times when the hydrant is not being used. When hydrant maintenance is required, cover can be adjusted to stay open by sliding it back into the box on its slotted hinge lugs when it is opened to the horizontal position.

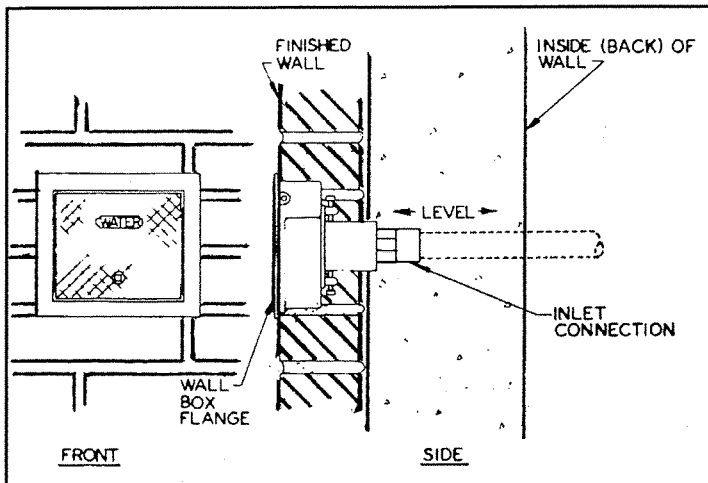

HYDRASAN I 71020 INSTALLATION
FIGURE 1

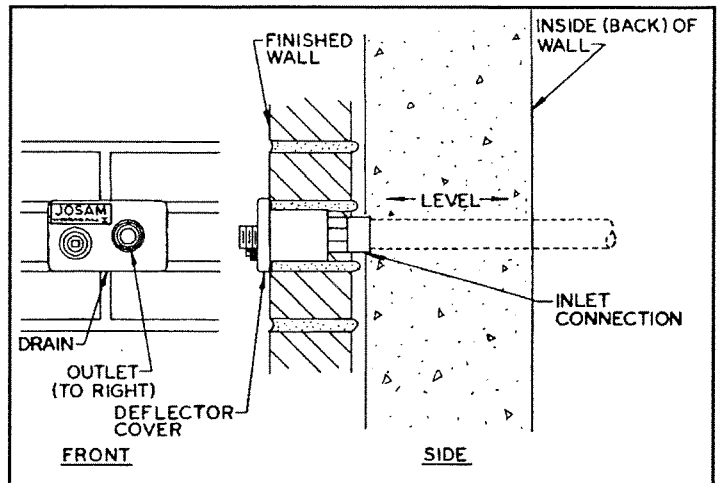

HYDRASAN I 71070 INSTALLATION
FIGURE 2

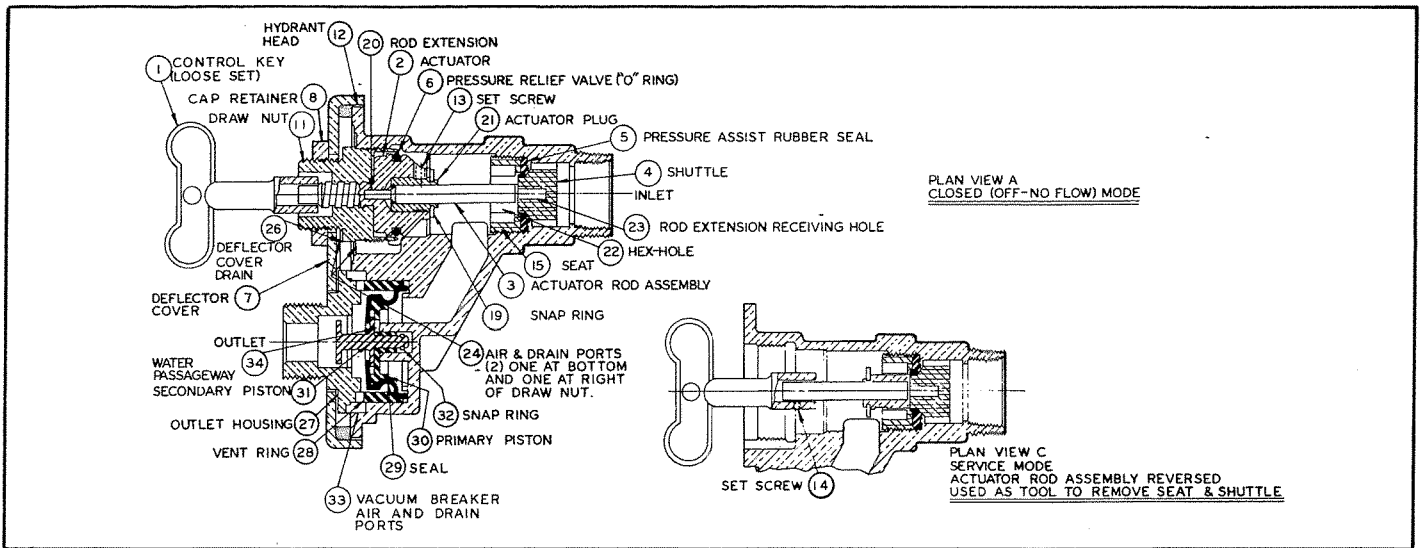

FIGURE 3

MAINTENANCE

HYDRASAN® I will seldom require service. However, continuous drainage from the outlet is a signal that inspection and possible replacement of certain parts are in order. A self-contained tool, Actuator Rod (3), when reversed, makes the job easy. The procedure for removal and replacement of hydrant sealing parts is as follows:

A. Shut off water in supply line to hydrant, and turn hydrant on to relieve pressure.

B. Use pliers. Firmly grip Cap Retainer (8) and turn counterclockwise to remove it, then remove Deflector Cap (7). Shut off hydrant as tight as possible with Control Key (1) and use an adjustable open end wrench or channel-lock type pliers to "break" Draw Nut (11) loose, then remove it with Control Key (1), turning counterclockwise until threads are free from Hydrant Head (12). Grasp Draw Nut (11) firmly and pull toward you to remove Actuator (2) and Actuator Rod (3). See Figure 4.

C. Loosen Set Screw (13) with a $\frac{3}{32}$ " hex. key and separate Actuator (2) from Actuator Plug (21) on end of Actuator Rod (3). See Figure 5.

D. Reverse Actuator Rod (3) and insert into hydrant as far as possible, using Control Key (1) secured to Actuator Rod (3) with Set Screw (14). With Actuator Plug (21) (hex.) on end of Actuator Rod (3) inserted in Hex. Hole (22) in Seat (15), which places Rod Extension (20) in Hole (23) in Shuttle (4), firmly rotate Control Key (1) counterclockwise to unscrew Seat (15) and pull out entire Valve (15, 5 and 4). See Figures 3, 6, and 7.

E. Replace worn parts with new parts as required. Reassemble hydrant, reversing the procedure in Steps A through D to place it back in service. Be sure to make Cap Retainer (8) tight to prevent tampering.

NOTE: If pressure relief Valve "O" Ring (6) appears worn, it should be replaced when hydrant is apart. This part can be checked and, if necessary, replaced without turning off water supply to hydrant because the Pressure Assist Seal (Parts 4, 5, and 15) prevents any water from entering. This feature makes possible removal of all parts downstream (in front) of the Seal (or Valve) with water supply on.

Should it ever be necessary to service the Vacuum Breaker-Backflow Preventer in the outlet of HYDRASAN I, the procedure for removal and replacement of operating parts is as follows:

F. After Deflector Cover (7) has been removed (see Maintenance Step B), remove the four housing retaining screws with a $\frac{5}{32}$ " hex. key and take off Outlet Housing (27). Lift out Vent Ring (28) and operating parts, Seal (29) Primary and Secondary Pistons (30 and 31). Inspect for wear.

G. Replace worn parts with new parts as required. Reassemble Vacuum Breaker-Backflow Preventer, reversing the procedure in Step F to place it back in service.

Service kits containing all parts necessary for this maintenance can be obtained through your plumbing supply dealer.

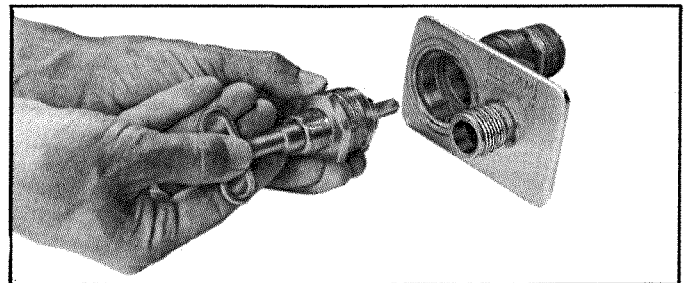

FIGURE 4

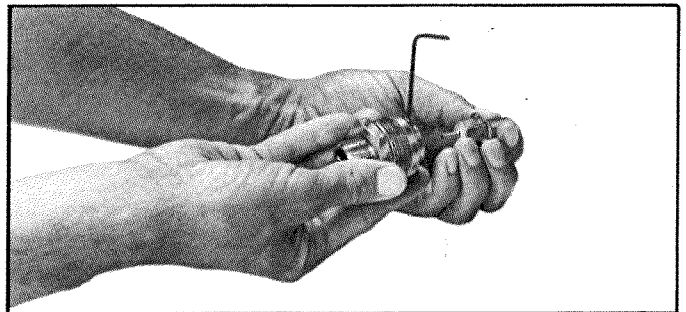

FIGURE 5

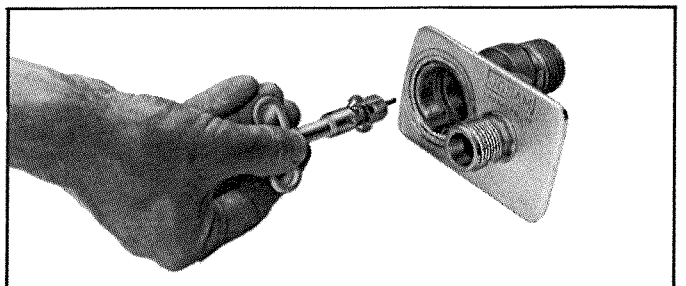

FIGURE 6

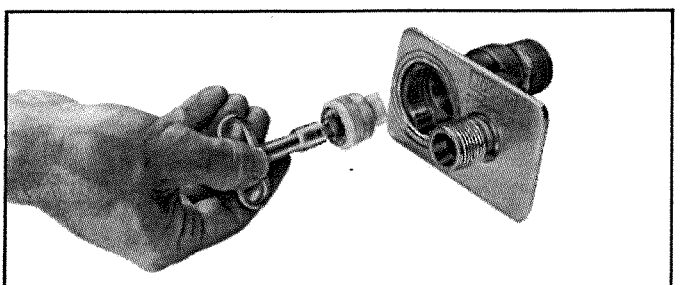

FIGURE 7

FROST FREE HYDRASAN® I

JOSAM MODELS 71000 and 71050 COMBINATION FROST-FREE HYDRANTS WITH VACUUM BREAKER-BACKFLOW PREVENTER AND PRESSURE RELIEF VALVE

— INSTRUCTIONS —

INSTALLATION OPERATION MAINTENANCE

CAUTION: Do not destroy this form — Leave with owner.

You have one of the finest frost-free hydrants available, JOSAM HYDRASAN I. Adherence to these instructions will ensure satisfactory installation and proper performance. Take a moment to read them now.

INSTALLATION

A. Model 71000 Assembly

If your hydrant is the box type (Model 71000), it will be necessary to assemble the wall box to the hydrant before proceeding with the installation. Open box cover using Control Key (1). Insert hydrant, inlet end first, through opening in box bottom. Be sure outlet (hose connection) is at right as you face box with cover hinged at top. With hydrant head flange seated in recess surrounding hole in box, secure hydrant in place by tightening the two set screws, in tabs or box bottom, against hydrant head.

B. Model 71000 and 71050 Installation

HYDRASAN I is installed, with head horizontal, outlet to right, in the manner typical to all frost-free hydrants. The face (front) of hydrant or hydrant wall box (with cover hinged at top) must be set with flange against finished wall overlapping wall opening provided for the hydrant. The casing or tubular portion of the hydrant must be level (plumb) and extend through the wall with valve body (inlet portion) on inside of wall (to prevent freezing). Grout the hydrant (and box) securely in place with mortar. Follow normal plumbing practice to make inlet connection. NOTE: This sequence may vary depending on job conditions. Refer to Figures 1 and 2.

BE SURE TO LEAVE CONTROL KEY AND HEX. KEYS (3/32") WITH OWNER.

CAUTION

If solder (sweat) connections are used, heat must be controlled to avoid damage to non-metallic hydrant components. For best results, remove pressure assist seal assembly (parts 4, 5, and 15) prior to soldering joint. Allow to cool before re-inserting pressure assist seal.

Before hydrant is put into service, water supply system must be flushed thoroughly to remove dirt and chips that could cause hydrant malfunction. Remove pressure assist seal assembly prior to flushing.

OPERATION

Refer to Figure 3 for identification of parts and features mentioned in these instructions.

A. ON-OFF

HYDRASAN I is turned on and off by Control Key (1). Rotate the key counterclockwise (left turn) to turn hydrant on and clockwise (right turn) to turn it off. Built-in stops prevent over-opening and over-closing. Some drainage after hydrant is turned off will be noted at outlet (hose connection) and Deflector Cover Drain (26). This is typical of mild climate hydrants and is not cause for alarm. NOTE: In the unlikely event of continuous drainage, it is a signal that service is necessary. This is covered in the Maintenance Section.

B. PRESSURE RELIEF

If a hose is attached at the time hydrant is turned off, and there is no nozzle on the hose, or if the nozzle is open, the hose will drain; however, if the nozzle is closed, the hose will not drain, but the pressure in the hose and hydrant will be relieved, dissipating through the Vent and Drain Ports (24) and Vacuum Breaker Ports (33), at which time there will be a momentary spurt of water from these ports.

C. VACUUM BREAKER-BACKFLOW PREVENTER

If for any reason a backflow condition should develop in the attached hose, i.e., pressure imbalance due to sudden supply pressure drop below outlet pressure, the Vacuum Breaker Seal (29) will instantly respond opening Air Ports (33), to break any vacuum and sealing against Piston (31) to prevent backflow from the attached hose and protect the water supply system from entry of contaminants.

D. BOX TYPE — MODEL 71000

Control Key (1) locks and unlocks the box. See instructions packed with box. The cover should be kept closed and locked at all times when the hydrant is not being used.

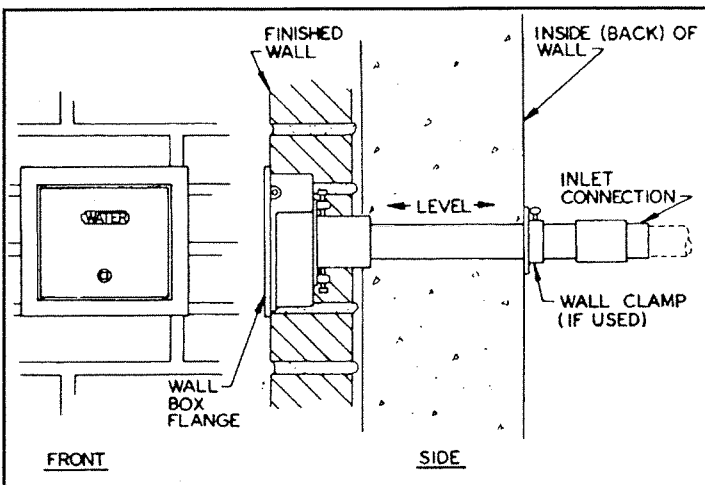

HYDRASAN I 71000 INSTALLATION
FIGURE 1

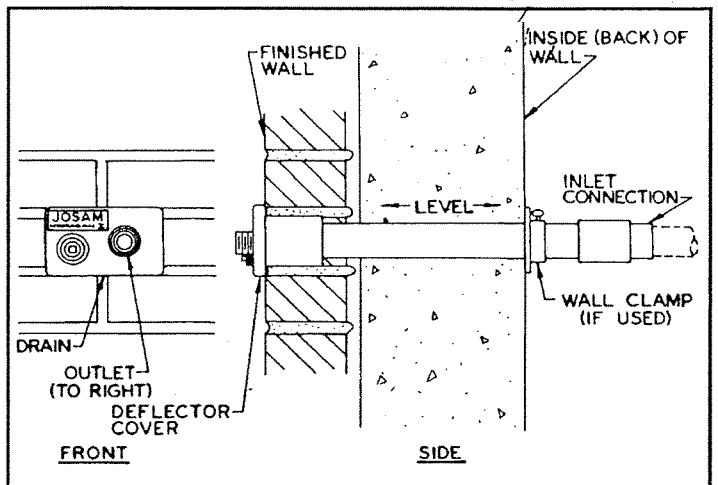

HYDRASAN I 71050 INSTALLATION
FIGURE 2

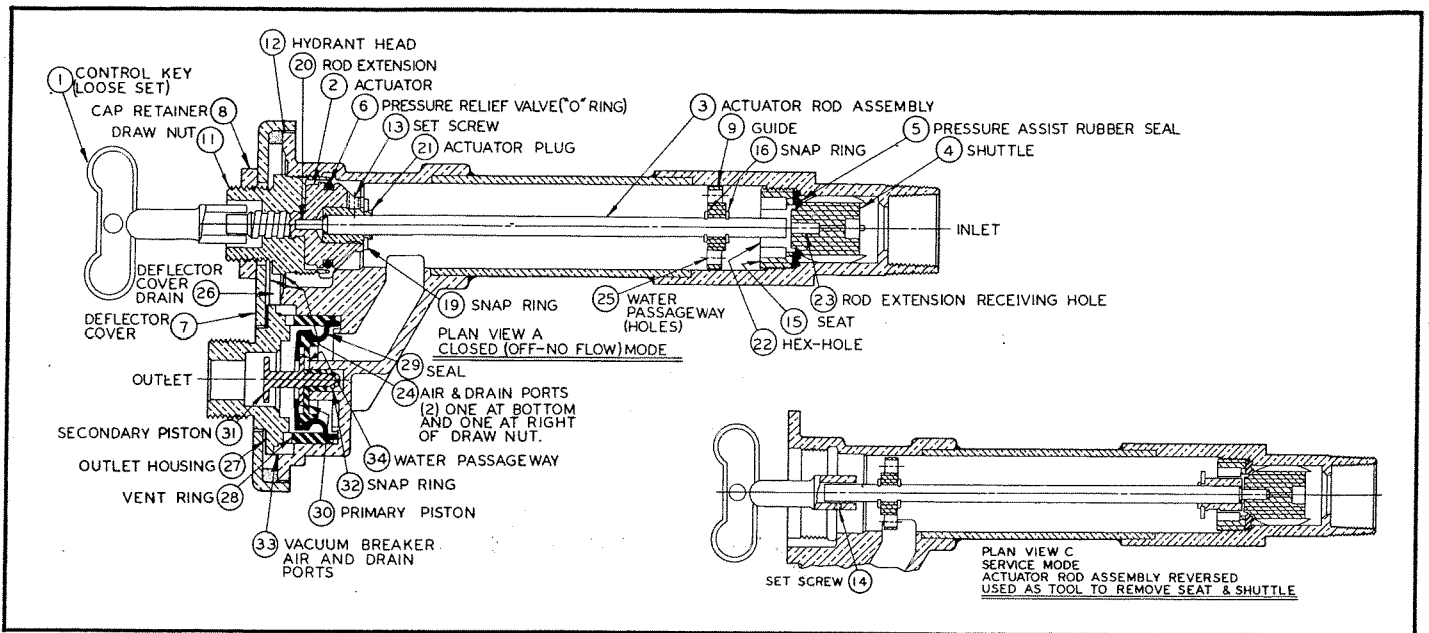

FIGURE 3

MAINTENANCE

HYDRASAN[®]I will seldom require service. However, *continuous drainage from the outlet is a signal that inspection and possible replacement of certain parts are in order. A self-contained tool, Actuator Rod (3), when reversed, makes the job easy.* The procedure for removal and replacement of hydrant sealing parts is as follows:

A. Shut off water in supply line to hydrant, and turn hydrant on to relieve pressure.

B. Use pliers. Firmly grip Cap Retainer (8) and turn counterclockwise to remove it, then remove Deflector Cover (7). *Shut off hydrant as tight as possible with Control Key (1) and use an adjustable open end wrench or channel-lock type pliers to "break" Draw Nut (11) loose, then remove it with Control Key (1), turning counterclockwise until threads are free from Hydrant Head (12). Grasp Draw Nut (11) firmly and pull toward you to remove Actuator (2) and Actuator Rod (3).* See Figure 4.

C. Loosen Set Screw (13) with a $\frac{3}{32}$ " hex. key and separate Actuator (2) from Actuator Plug (21) on end of Actuator Rod (3). See Figure 5.

D. Reverse Actuator Rod (3) and insert into hydrant as far as possible, using Control Key (1) secured to Actuator Rod (3) with Set Screw (14). With Actuator Plug (21) (hex.) on end of Actuator Rod (3) inserted in Hex. Hole (22) in Seat (15), which places Rod Extension (20) in Hole (23) in Shuttle (4), *firmly rotate Control Key (1) counterclockwise to unscrew Seat (15) and pull out entire Valve (15, 5 and 4).* See Figures 3, 6, and 7.

E. Replace worn parts with new parts as required. Reassemble hydrant, reversing the procedure in Steps A through D to place it back in service. Be sure to make Cap Retainer (8) tight to prevent tampering.

NOTE: If pressure relief Valve "O" Ring (6) appears worn, it should be replaced when hydrant is apart. *This part can be checked and, if necessary, replaced without turning off water supply to hydrant because the Pressure Assist Seal (Parts 4, 5, and 15) prevents any water from entering.* This feature makes possible removal of all parts downstream (in front) of the Seal (or Valve) with water supply on.

Should it ever be necessary to service the Vacuum Breaker-Backflow Preventer in the outlet of HYDRASAN[®]I, the procedure for removal and replacement of operating parts is as follows:

F. After Deflector Cover (7) has been removed (see Maintenance Step B), remove the four housing retaining screws and take off Outlet Housing (27). Lift out Vent Ring (28) and operating parts, Seal (29), Primary and Secondary Pistons (30 and 31). Inspect for wear.

G. Replace worn parts with new parts as required. Reassemble Vacuum Breaker-Backflow Preventer, reversing the procedure in Step F to place it back in service.

Service kits containing all parts necessary for this maintenance can be obtained through your plumbing supply dealer.

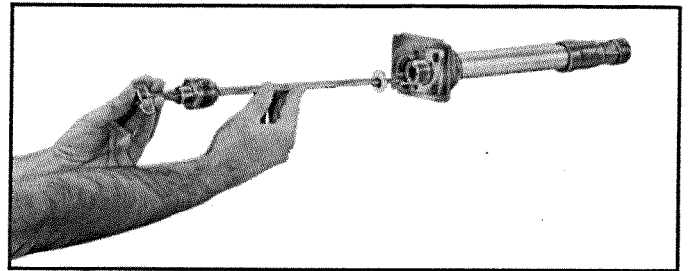

FIGURE 4

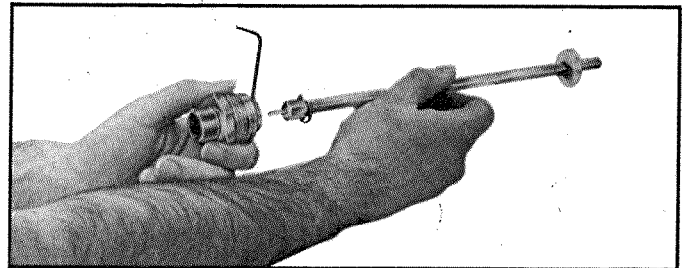

FIGURE 5

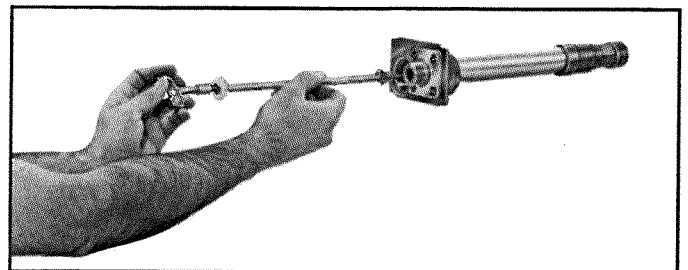

FIGURE 6

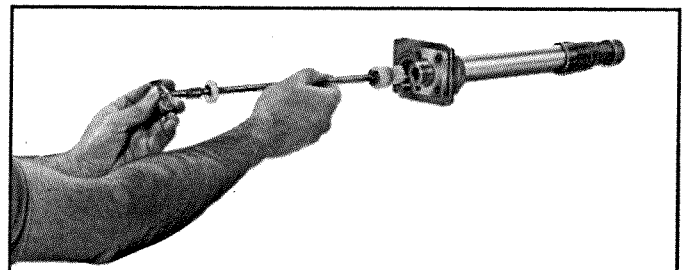

FIGURE 7

FROST FREE
HYDRASAN® II
JOSAM MODELS 71150 and 71200
COMBINATION FROST-FREE HYDRANTS
WITH VACUUM BREAKER-BACKFLOW PREVENTER
AND PRESSURE RELIEF VALVE

— INSTRUCTIONS —
INSTALLATION OPERATION MAINTENANCE
CAUTION: Do not destroy this form — Leave with owner.

You have one of the finest frost-free hydrants available, JOSAM HYDRASAN II. Adherence to these instructions will ensure satisfactory installation and proper performance. Take a moment to read them now.

INSTALLATION

A. Model 71150 Assembly

If your hydrant is the box type (Model 71150), it will be necessary to assemble the wall box to the hydrant before proceeding with the installation. Open box cover using Control Key (1). Insert hydrant, inlet end first, through opening in box bottom. *Be sure outlet (hose connection) is at right as you face box with cover hinged at top.* With hydrant head flange seated in recess surrounding hole in box, secure hydrant in place by tightening the two set screws, in tabs on box bottom, against hydrant head.

B. Model 71150 and 71200 Installation

HYDRASAN II is installed in the manner typical to all frost-free hydrants. The face (front) of hydrant or hydrant wall box must be set with flange against finished wall overlapping wall opening provided for the hydrant. The casing or tubular portion of the hydrant must be level (plumb) and extend through the wall with valve body (inlet portion) on inside of wall (to prevent freezing). Grout the hydrant (and box) securely in place with mortar. If wall clamp is used, it should be secured to hydrant casing at this time. Follow normal plumbing practice to make inlet connection. **NOTE:** This sequence may vary depending on job conditions. *HYDRASAN II is shipped with Deflector Cap (7) assembled with Drain (26) at bottom for head horizontal, outlet to right installation.* For optional head vertical, outlet below, installation (71200 only), loosen Cap Retainer (8) and rotate Deflector Cap (7) counterclockwise one quarter turn to place Drain (26) at bottom and retighten Cap Retainer (8). Refer to Figures 1 and 2.

BE SURE TO LEAVE CONTROL KEY AND 3/32" KEYS WITH OWNER.

CAUTION

If solder (sweat) connections are used, heat must be controlled to avoid damage to non-metallic hydrant components. For best results, remove pressure assist seal assembly (parts 4, 5, and 15) prior to soldering joint. Allow to cool before re-inserting pressure assist seal.

Before hydrant is put into service, water supply system must be flushed thoroughly to remove dirt and chips that could cause hydrant malfunction. Remove pressure assist seal assembly prior to flushing.

OPERATION

Refer to Figure 3 for identification of parts and features mentioned in these instructions.

A. ON-OFF

HYDRASAN II is turned on and off by Control Key (1). Rotate the key counterclockwise (left turn) to turn hydrant on and clockwise (right turn) to turn it off. Built-in stops prevent over-opening and over-closing. *Some drainage after hydrant is turned off will be noted at outlet (hose connection) and Deflector Cap Drain (26). This is typical of frost-free hydrants and is not cause for alarm.* **NOTE:** In the unlikely event of continuous drainage, it is a signal that service is necessary. This is covered in the Maintenance Section.

B. PRESSURE RELIEF

If a hose is attached at the time hydrant is turned off, and there is no nozzle on the hose, or if the nozzle is open, the hose will drain; however, if the nozzle is closed, the hose will not drain, but the pressure in the hose and hydrant will be relieved, dissipating through the Vent and Drain (26), at which time there will be a momentary spurt of water from the drain.

C. BACKFLOW PREVENTER

If for any reason a backflow condition should develop in the attached hose, i.e., *pressure imbalance due to sudden supply pressure drop below outlet pressure*, the backflow preventer Valve (10) will automatically seal off upstream end of hydrant and the water supply system from entry of contaminants.

D. BOX TYPE — MODEL 71150

Control Key (1) locks and unlocks the box. *Do not store the key in the box.* The cover should be kept closed and locked at all times when hydrant is not being used. When hydrant maintenance is required, cover can be adjusted to stay open by sliding it back into the box on its slotted hinge lugs when it is opened to the horizontal position.

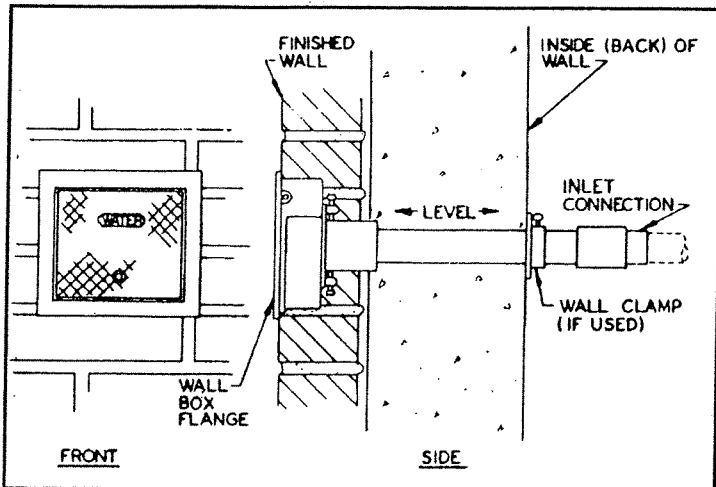

HYDRASAN II 71150 INSTALLATION
 FIGURE 1

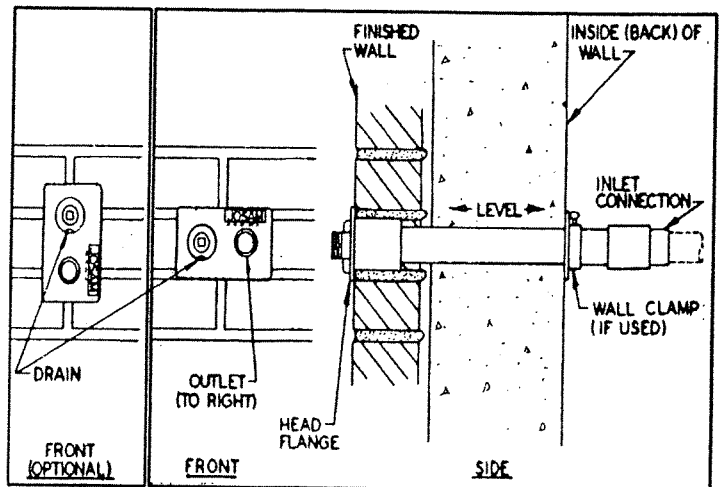

HYDRASAN II 71200 INSTALLATION
 FIGURE 2

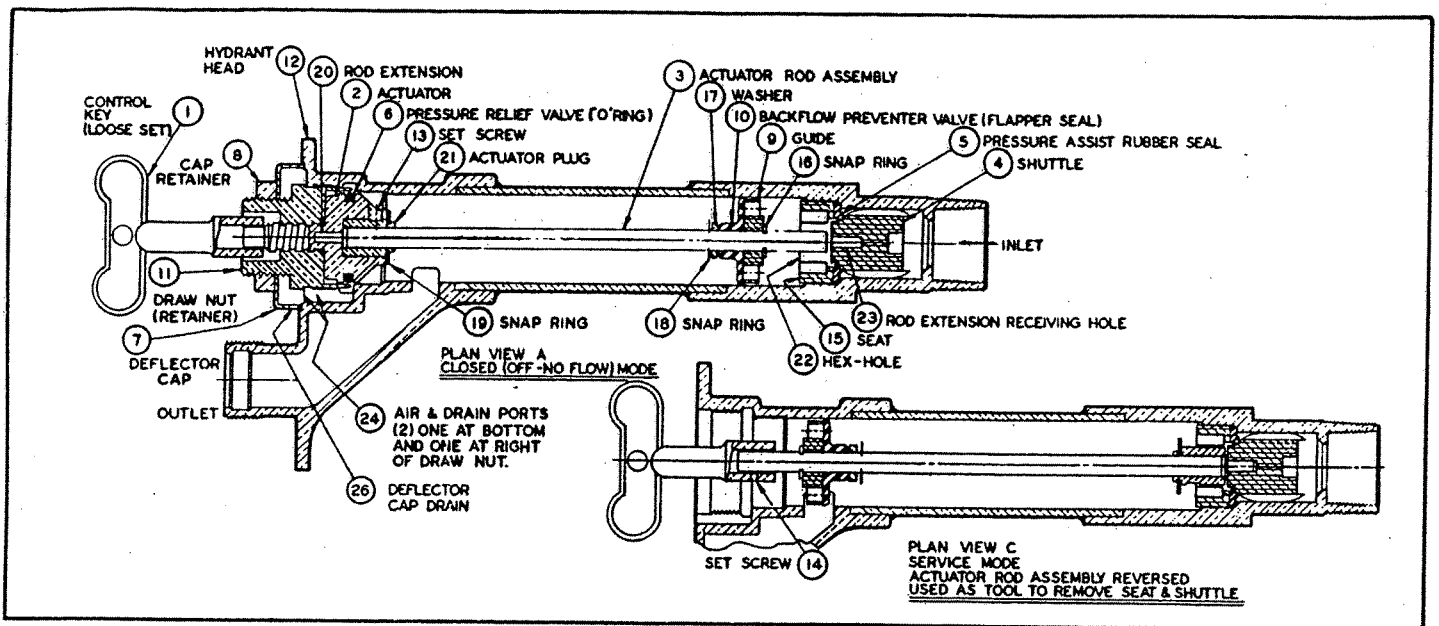

FIGURE 3

MAINTENANCE

HYDRASAN® will seldom require service. However, continuous drainage from the outlet is a signal that inspection and possible replacement of certain parts are in order. A self-contained tool, Actuator Rod (3), when reversed, makes the job easy. The procedure for removal and replacement of hydrant sealing parts is as follows:

A. Shut off water in supply line to hydrant.

B. Use pliers. Firmly grip Cap Retainer (8) and turn counterclockwise to remove it, then remove Deflector Cap (7). Shut off hydrant as tight as possible with Control Key (1) and use an adjustable open-end wrench or channel-lock type pliers to "break" Draw Nut (11) loose, then remove it with Control Key (1), turning counterclockwise until threads are free from Hydrant Head (12). Grasp Draw Nut (11) firmly and pull toward you to remove Actuator (2) and Actuator Rod (3). A vacuum is created between Shuttle (4) and backflow preventer Valve (10) making a firm grip and pull necessary to accomplish this step. Some agitation while pulling will be helpful. See Figure 4.

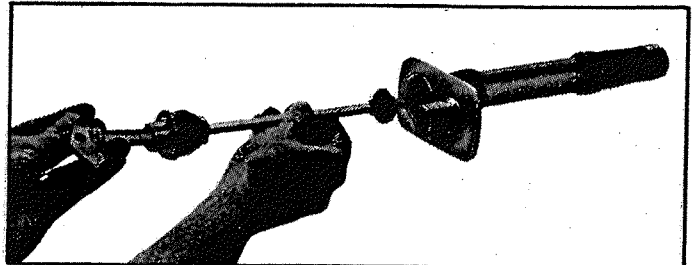

FIGURE 4

C. Loosen Set Screw (13) with a $\frac{3}{16}$ " hex. key and separate Actuator (2) from Actuator Plug (21) on end of Actuator Rod (3). See Figure 5.

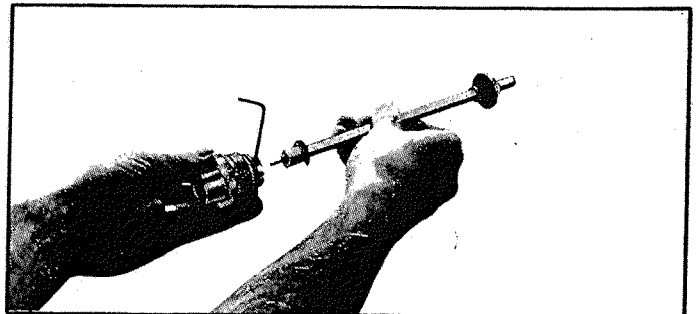

FIGURE 5

D. Reverse Actuator Rod (3) and insert into hydrant as far as possible, using Control Key (1) secured to Actuator Rod (3) with Set Screw (14). With Actuator Plug (21) (hex.) on end of Actuator Rod (3) inserted in Hex. Hole (22) in Seat (15), which places Rod Extension (20) in Hole (23) in Shuttle (4), firmly rotate Control Key (1) counterclockwise to unscrew Seat (15) and pull out entire Valve (15, 5 and 4). See Figures 3, 6, and 7.

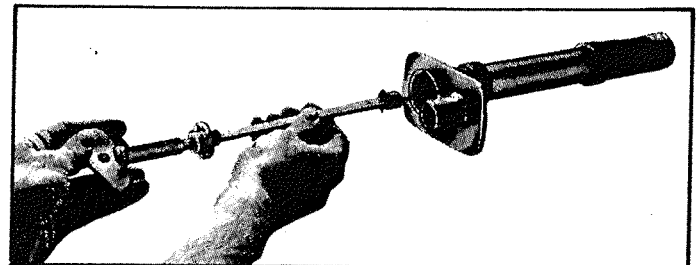

FIGURE 6

E. Replace worn parts with new parts as required, reassemble hydrant, reversing the procedure in Steps A through D to place it back in service. Use silicone lubricant to ease assembly. Be sure to reassemble Deflector Cap (7) with Drain (26) at bottom and make Cap Retainer (8) tight to prevent tampering.

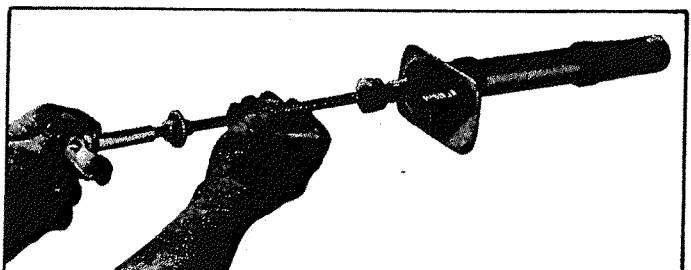

FIGURE 7

NOTE: If pressure relief Valve "O" Ring (6) or the backflow preventer Valve (10) appears worn, it should be replaced when hydrant is apart. To remove backflow preventer Valve (10), remove Snap Ring (16) with nail or pick, slide Guide (9) and backflow preventer Valve (10) off Actuator Rod (3), assemble new backflow preventer Valve (10) in reverse order, making sure it is snug against Washer (17) before Snap Ring (16) is replaced. These parts can be checked and, if necessary, replaced without turning off water supply to hydrant because the Pressure Assist Seal (Parts 4, 5, and 15) prevents any water from entering. This feature makes possible removal of all parts downstream (in front) of the Seal (or Valve) with water supply on.

Service kits containing all parts necessary for this maintenance can be obtained through your plumbing supply dealer.

SECTION I

Hydrant Packages & Kits

HYDRANT REPAIR KITS

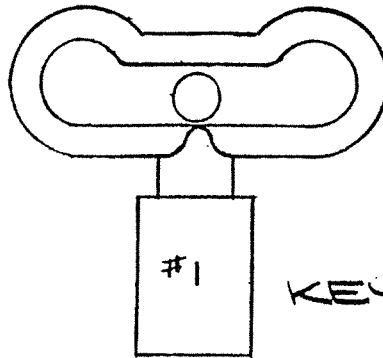

QTY. 12

KEY

KIT #2

71550P02U

**FOR 1400N - 1410N OLD STYLE
AND 71500 - 71550 NEW STYLE**

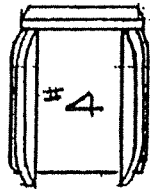
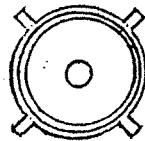

SHUTTLE

QTY. 2 EACH

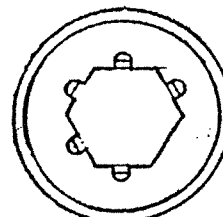

#5/15



SEAL/SEAT

KIT #6

71050P06U

HYDRASAN I & II NON-FREEZE

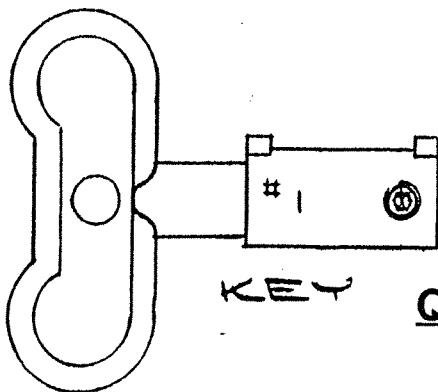

KEY

QTY. 12 EACH

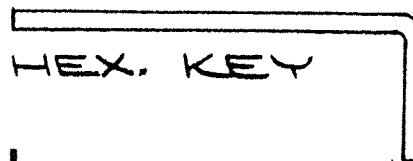

HEX. KEY

KIT #7

71050P07U

FOR HYDRASAN I & II

HYDRANT REPAIR KITS

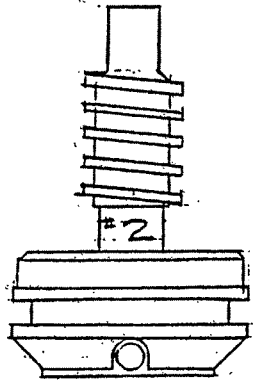

ACTUATOR

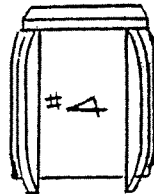
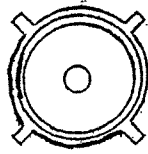

SHUTTLE

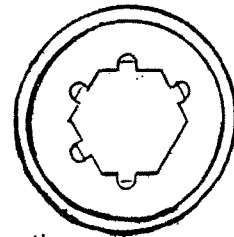

#5/15



SEAL/SEAT

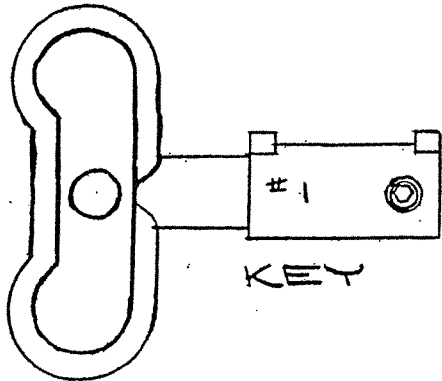

KEY

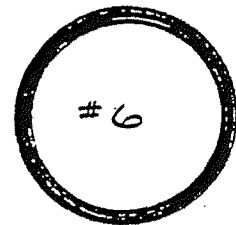
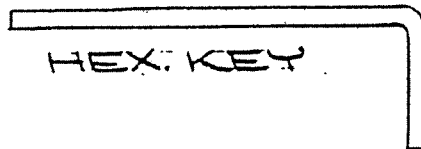

"O" RING

KIT #8
71050P08U

FOR HYDRASAN I & II NON-FREEZE

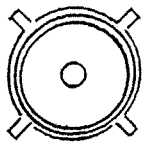

SHUTTLE

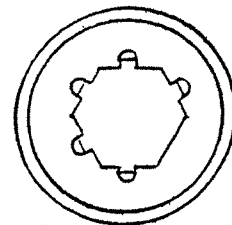

#5/15

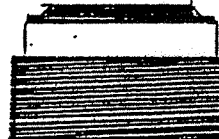

SEAL/SEAT

QTY. 2 EACH

KIT #9
71070P09U

FOR HYDRASAN I & II MILD CLIMATE

HYDRANT REPAIR KITS

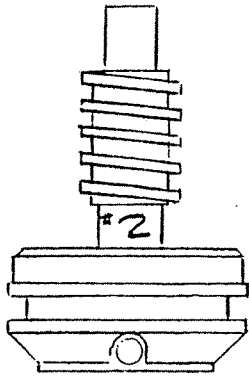

ACTUATOR

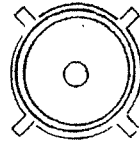

SHUTTLE

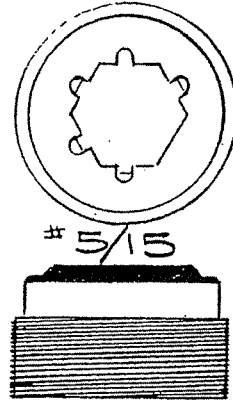

SEAL/SEAT

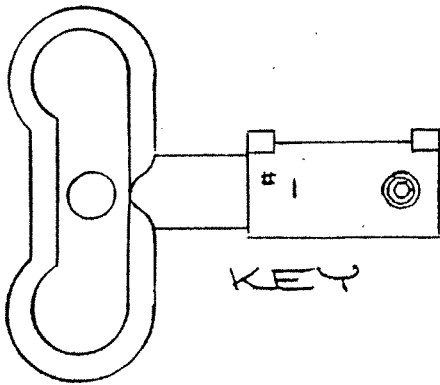

KEY

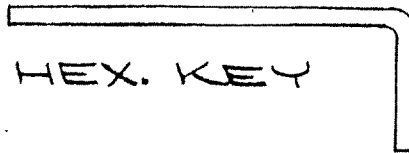

HEX. KEY

"O" RING

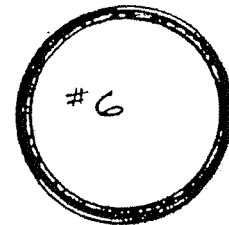

KIT #10
71070P10U
HYDRASAN I & II MILD CLIMATE

HYDRANT REPAIR KITS

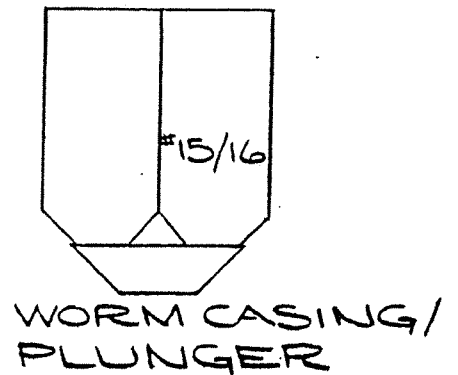
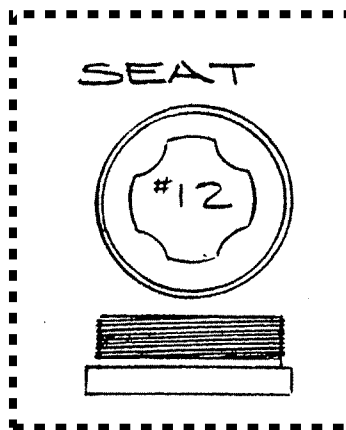
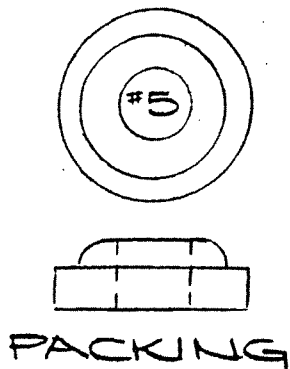
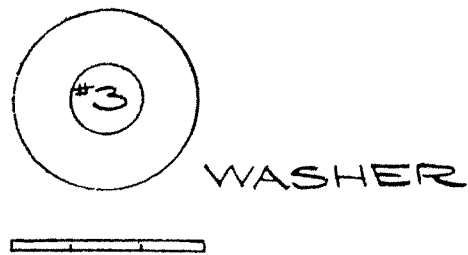
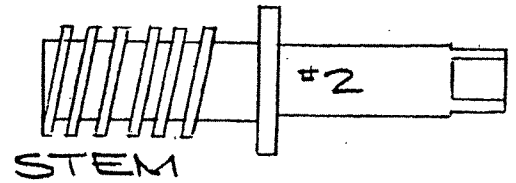
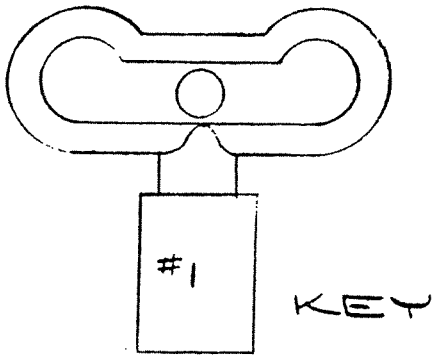

2025
NO LONGER PART OF KIT
ORDER SEPARATELY AS 018014

KIT #12
71950P12U
FOR 1420N O.S. - 71950 N.S.

HYDRANT REPAIR KITS

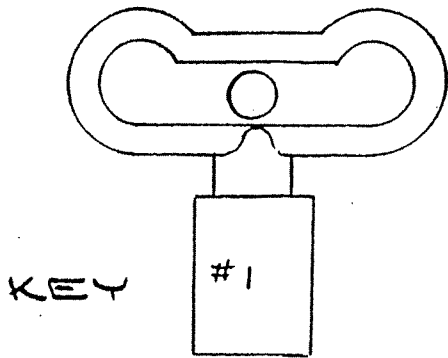

KEY

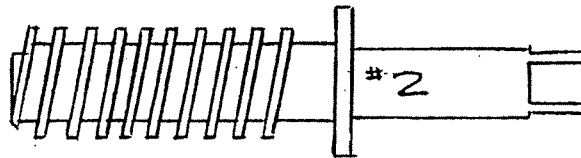

STEM

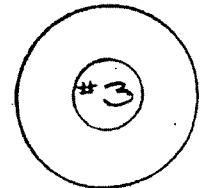

WASHER

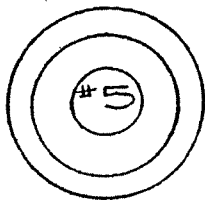

PACKING

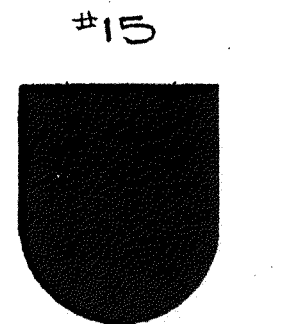

PLUNGER

KIT #14
71600P14U
FOR 1430N O.S. 3/4 or 1"
AND 1440N O.S. - 71700 O.S. 3/4"

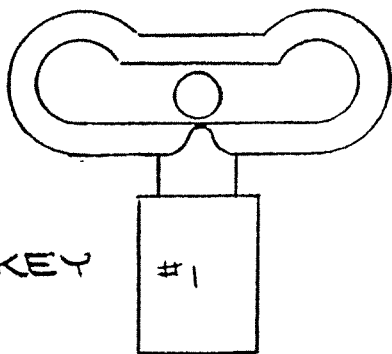

KEY

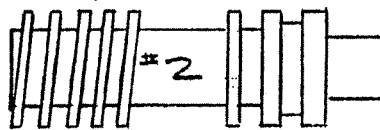

STEM

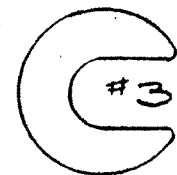

WASHER

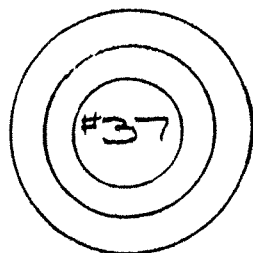

NYLON SEAL



STEM SEAL

#15

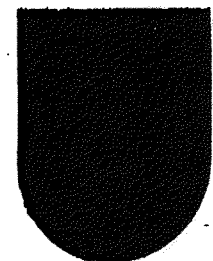

PLUNGER

KIT #15
71600P15U
FOR 71600 3/4" OR 1" N.S.

HYDRANT REPAIR KITS

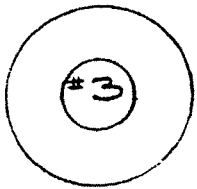
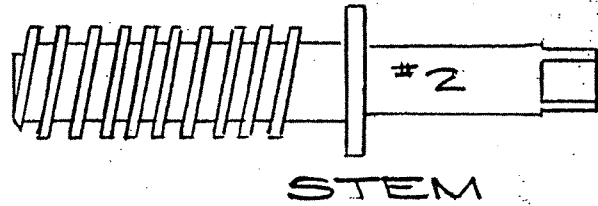
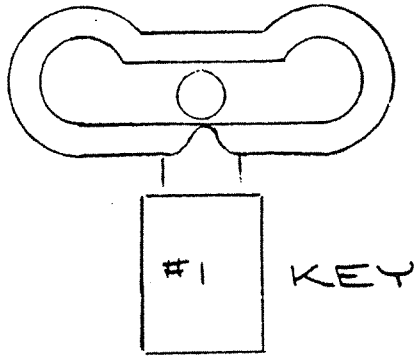

WASHER

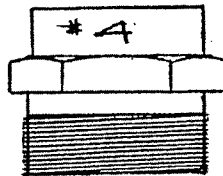

PACKING NUT

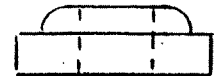
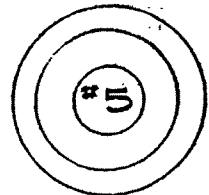

PACKING

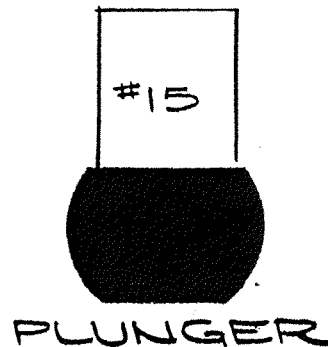
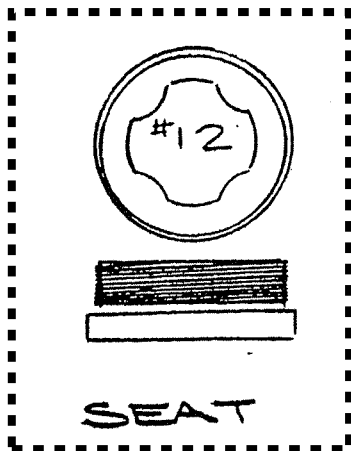

2025
NO LONGER PART OF KIT
ORDER SEPARATELY AS 018014

KIT #21
71550P21U
FOR 1400 - 1410N O.S.
AND 71550 - 71650 PREVIOUS DESIGN

HYDRANT REPAIR KITS

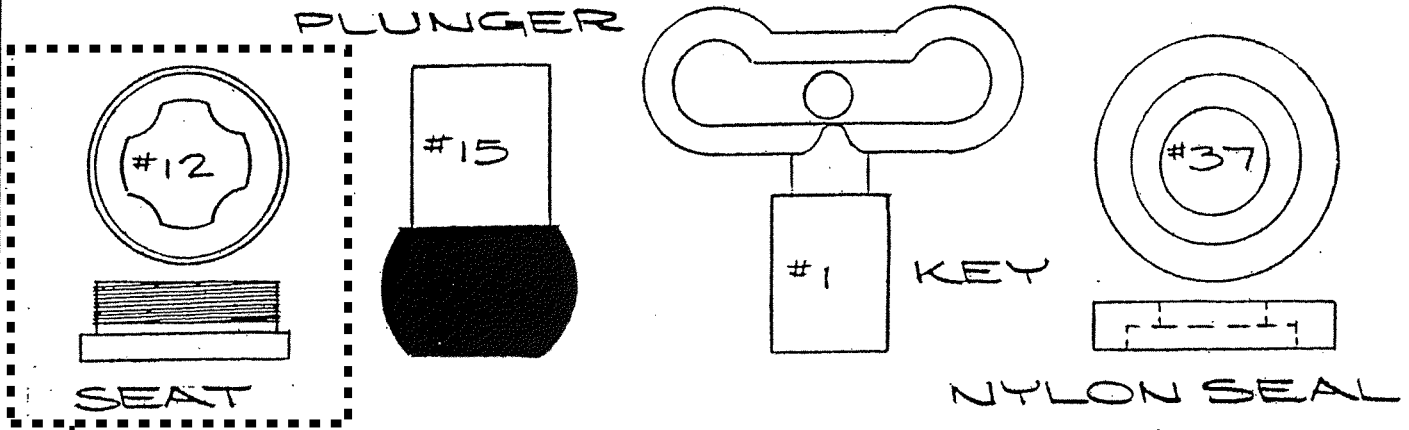

2025
NO LONGER PART OF KIT
ORDER SEPARATELY AS 018014

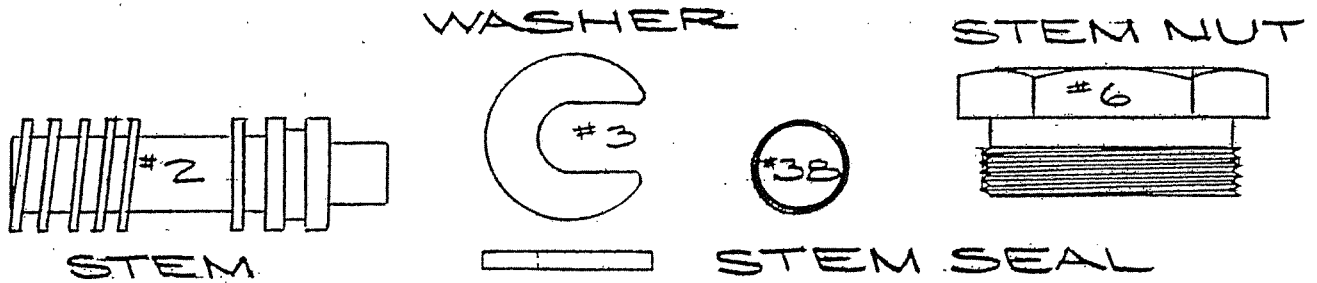

KIT #22
71550P22U
FOR 71500 - 71550 71650 N.S.

KIT 23 VACUUM BREAKER ASSEMBLY FOR HYDRASAN I

2 EACH (ASSEMBLED)

- VENT RING
- BOOTE F/VACUUM BREAKER
- PRIMARY PISTON
- SECONDARY PISTON
- SNAP RING VACUUM BREAKER

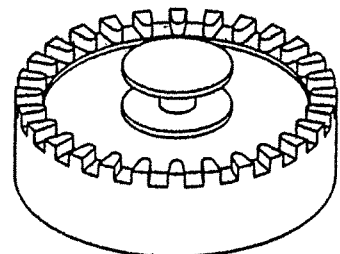

SECTION II

Rod Assemblies

HYDRANT ROD ASSEMBLIES

ROD LENGTHS AND RELATED DIMENSIONS BASED ON WALL THICKNESS.

ACTUATOR ROD HYDRASAN I

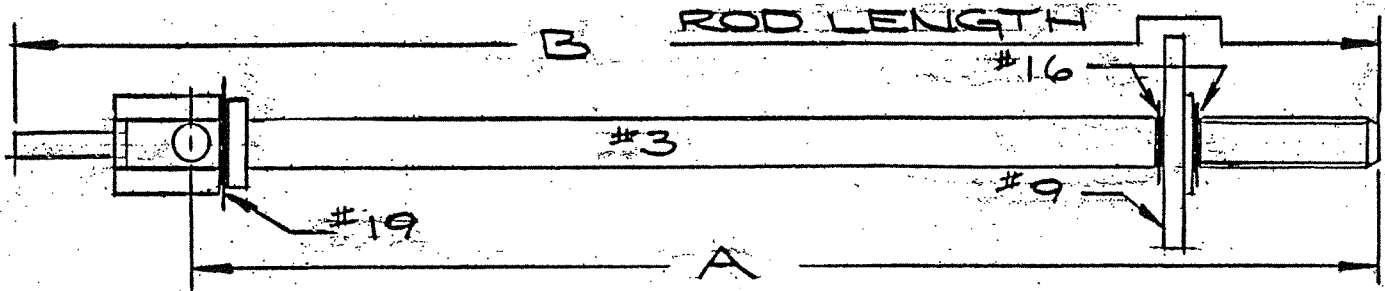

CODE NO.	ROD LENGTH		A	B
	71000	71050		
09589B	4"	2"	3 15/16	4 7/8
09589C	6"	4"	5 15/16	6 7/8
09589D	8"	6"	7 15/16	8 7/8
09589E	10"	8"	9 15/16	10 7/8
09589F	12"	10"	11 15/16	12 7/8
09589G	14"	12"	13 15/16	14 7/8
09589H	16"	14"	15 15/16	16 7/8
09589J	18"	16"	17 15/16	18 7/8
09589K	20"	18"	19 15/16	20 7/8
09589L	22"	20"	21 15/16	22 7/8
09589M	24"	22"	23 15/16	24 7/8
09589N	--	24"	25 15/16	26 7/8

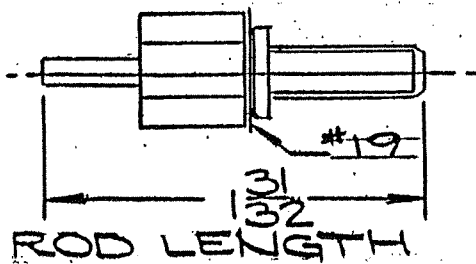

CODE NO. 09581S

ACTUATOR ROD FOR
 71020 & 71070 HYDRASAN I
 71170 & 71220 HYDRASAN II
 MILD CLIMATE HYDRANTS

HYDRANT ROD ASSEMBLIES

ROD LENGTHS AND RELATED DIMENSIONS BASED ON WALL THICKNESS.

ACTUATOR ROD HYDRASAN II

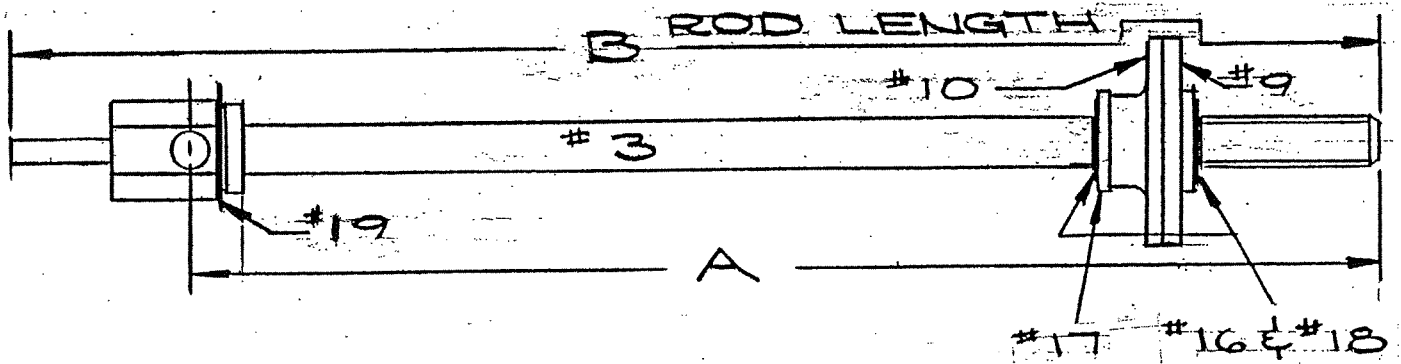

ROD ASSY. CODE NO.	WALL THICKNESS		A	B
	71150	71200		
09581J	4"	2 3/4"	3 15/16	4 7/8
09581K	6"	4"	5 15/16	6 7/8
09581L	8"	6"	7 15/16	8 7/8
09581M	10"	8"	9 15/16	10 7/8
09581N	12"	10"	11 15/16	12 7/8
09581P	14"	12"	13 15/16	14 7/8
09581Q	16"	14"	15 15/16	16 7/8
09581R	18"	16"	17 15/16	18 7/8
09581T	20"	18"	19 15/16	20 7/8
09581U	22"	20"	21 15/16	22 7/8
09581V	24"	22"	23 15/16	24 7/8
09581W	--	24"	25 15/16	26 7/8

HYDRANT ROD ASSEMBLIES

ROD LENGTHS AND RELATED DIMENSIONS BASED ON DEPTH OF BURY.

71600-3/4" & 1" VALVE ROD

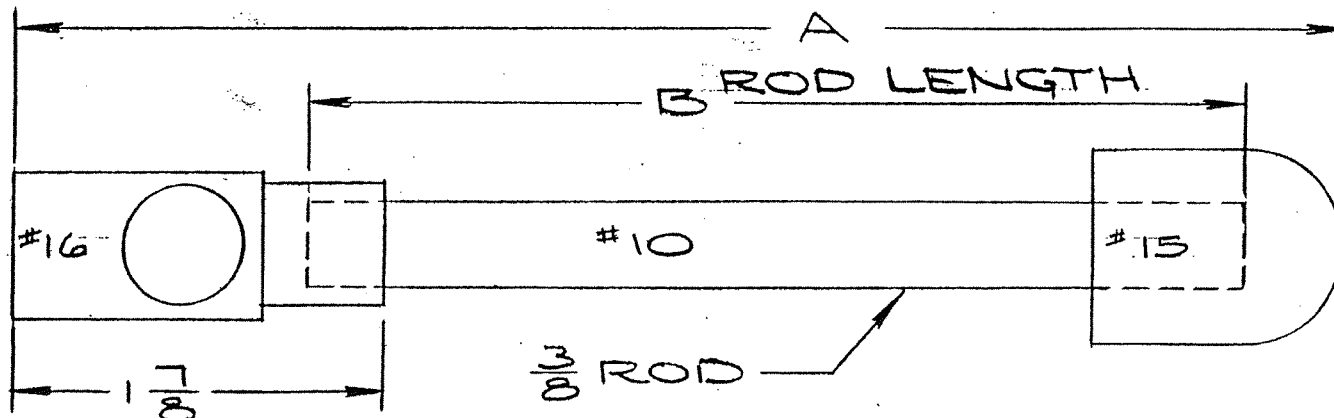

ROD ASSY. CODE NO.	DEPTH OF BURY	A	B
01800A	2'	21 5/16	19 1/2
01800B	3'	33 5/16	31 1/2
01800C	4'	45 5/16	43 1/2
01800D	5'	57 5/16	55 1/2
01800E	6'	69 5/16	67 1/2
01800F	7'	81 5/16	79 1/2
01800G	8'	93 5/16	91 1/2
01800H	9'	105 5/16	103 1/2
01800J	10'	117 5/16	115 1/2

HYDRANT ROD ASSEMBLIES

ROD LENGTHS AND RELATED DIMENSIONS BASED ON DEPTH OF BURY.

71700-3/4 VALVE ROD

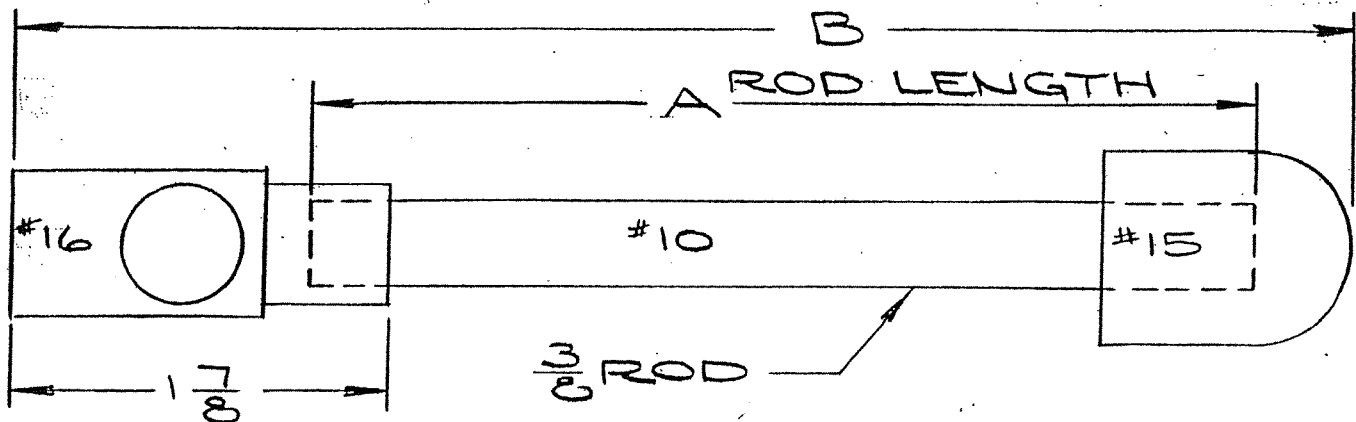

ROD ASSY. CODE NO.	DEPTH OF BURY	A	B
01856A	2'	53 5/8	55 1/4
01856B	3'	65 5/8	67 1/4
01856C	4'	77 5/8	79 1/4
01856D	5'	89 5/8	91 1/4
01856E	6'	101 5/8	103 1/4
01856F	7'	113 5/8	115 1/4
01856G	8'	125 5/8	127 1/4
01856H	9'	137 5/8	139 1/4
01856J	10'	149 5/8	151 1/4

HYDRANT ROD ASSEMBLIES

ROD LENGTHS AND RELATED DIMENSIONS BASED ON WALL THICKNESS.

1400N-1410N & 71500-71550 NEW STYLE VALVE ROD

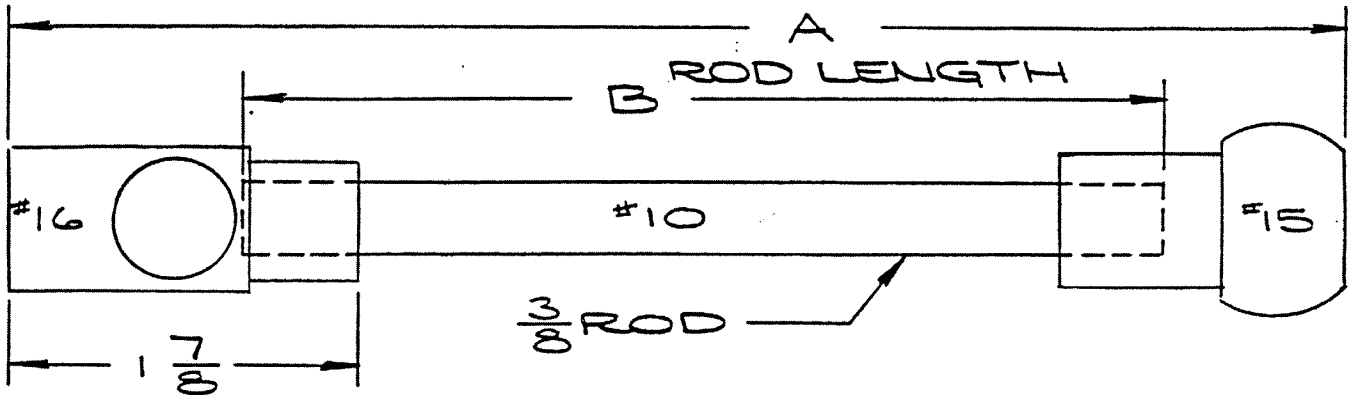

ROD ASSY. CODE NO.	WALL THICKNESS		A	B
	71500	71550		
01857K	6"	4"	3 15/16	1 7/8
01857L	8"	6"	5 15/16	3 7/8
01857M	10"	8"	7 15/16	5 7/8
01857N	12"	10"	9 15/16	7 7/8
01857P	14"	12"	11 15/16	9 7/8
01857Q	16"	14"	13 15/16	11 7/8
01857R	18"	16"	15 15/16	13 7/8
01857S	20"	18"	17 15/16	15 7/8
01857T	22"	20"	19 15/16	17 7/8
01857U	24"	22"	21 15/16	19 7/8
01857V	--	24"	23 15/16	21 7/8

HYDRANT ROD ASSEMBLIES

ROD LENGTHS AND RELATED DIMENSIONS BASED ON WALL THICKNESS.

1400N-1410N OLD STYLE VALVE ROD

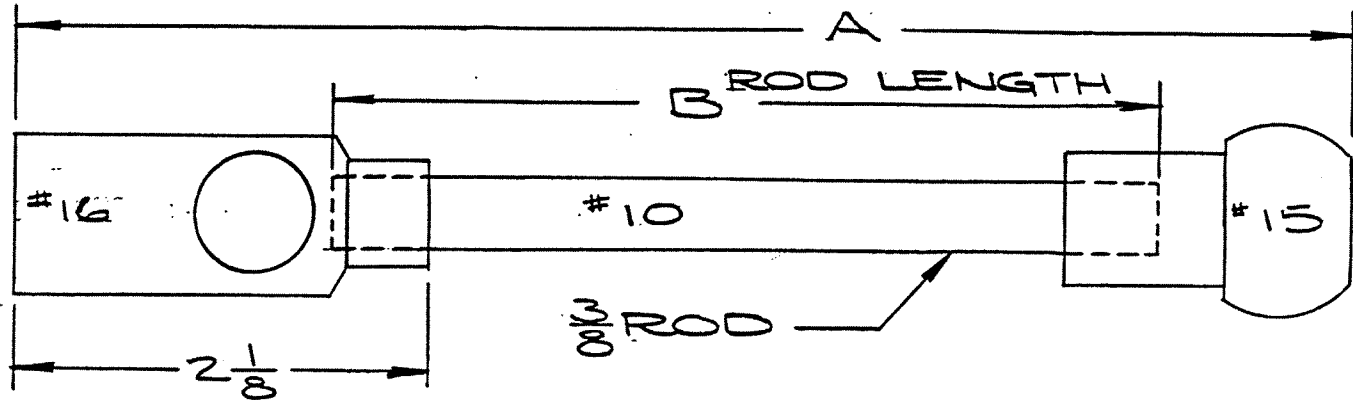

ROD ASSY. CODE NO.	WALL THICKNESS		A	B
	1410N	1400N		
01858A	6"	4"	4 5/16	1 7/8
01858B	8"	6"	6 5/16	3 7/8
01858C	10"	8"	8 5/16	5 7/8
01858D	12"	10"	10 5/16	7 7/8
01858E	14"	12"	12 5/16	9 7/8
01858F	16"	14"	14 5/16	11 7/8
01858G	18"	16"	16 5/16	13 7/8
01858H	20"	18"	18 5/16	15 7/8
01858J	22"	20"	20 5/16	17 7/8
01858K	24"	22"	22 5/16	19 7/8
01858L	--	24"	24 5/16	21 7/8